

# Product Specification

Specification Number 675 A9268

Revision 01

Part No.	675 A9268
Description	Toggle Drum 8L
Materials of Construction:	<ul style="list-style-type: none"> <li>- Body: 316 stainless steel</li> <li>- Lid: 316 stainless steel</li> <li>- Toggles: 304 stainless steel</li> <li>- Handles: 304 stainless steel</li> <li>- Gasket: Silicone (FDA 177.2600 and USP Class VI compliant)</li> </ul>

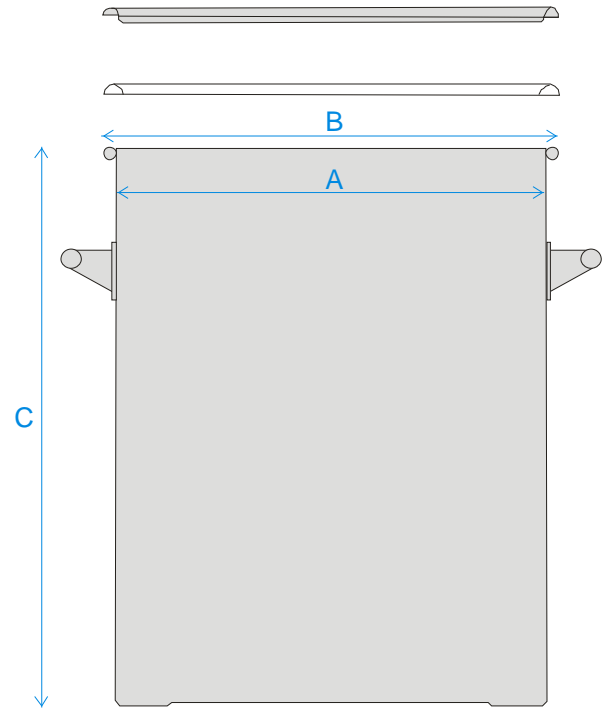

Nominal Volume:	8 Litres
Brimful Volume:	9 Litres
Method of Construction:	Welds ground and polished
Surface Finish:	Better than 0.5 microns Ra
Dimensions	<ul style="list-style-type: none"> <li>A = 196 mm</li> <li>B = 216 mm</li> <li>C = 300 mm</li> </ul>
Graduation Marks:	None
Handles:	2 side handles welded onto patch plates
Number of Toggles:	4
Weight:	3.2 Kg (body + gasket + lid)