

1. Part Number: 675 A81610

2. Photograph:

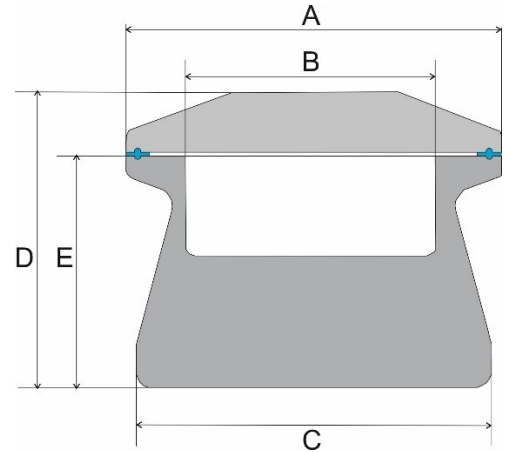

3. Product Information:

Description	Tri-Ferrule Bottle 10ml
Materials of Construction:	- Body: 316L stainless steel - Lid: 316L stainless steel - Gasket: Silicone (FDA 21 CFR 177.2600 compliant)
Nominal Volume:	10ml
Method of Construction:	Crevice free interior, welds ground & polished
Surface Finish:	Better than 0.5 microns Ra
Dimensions:	A = 50.5 mm B = 34 mm C = 48 mm D = 44 mm E = 35 mm Max. Width over the Clamp = 95 mm
Nominal Weight (body, lid, clamp & gasket):	580 g
BSE/TSE statement:	All polishing compounds used in the manufacture of this product are of vegetable origin.
Recommended Storage Conditions:	Dry and ambient temperature

4. Approval:

Signed:



Name: Kuldeep Flora

Position: Quality Manager

Date: 23-Feb-23