

# Product Specification

Specification Number

675 A12650

Revision

03

Part No. 675 A12650

Description Stainless Storage Drum 50L

Materials of Construction:

- Body: 316L stainless steel
- Lid: 316L stainless steel
- Clamp: 304 stainless steel
- Handles: 304 stainless steel
- Gasket: Silicone (FDA 177.2600 and USP Class VI compliant)

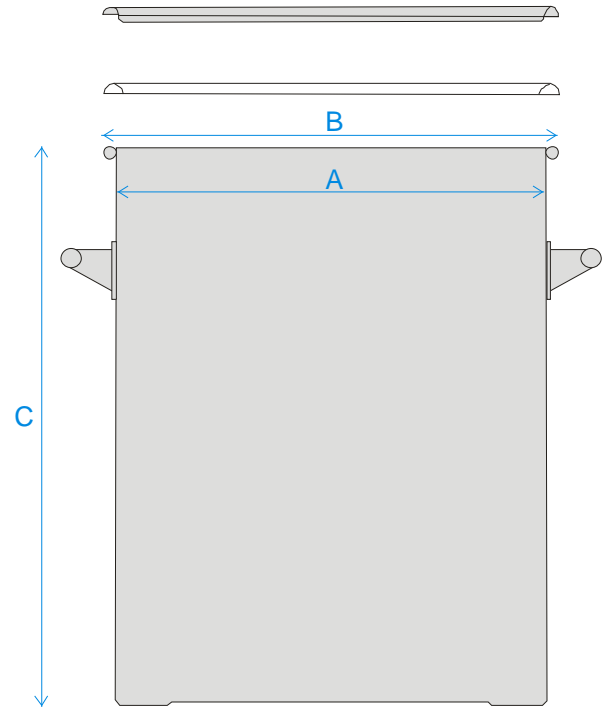

Nominal Volume: 50 Litres

Method of Construction: Welds ground and polished

Surface Finish: Better than 0.5 microns Ra

Dimensions  
 A = 394 mm  
 B = 414 mm  
 C = 431 mm

Graduation Marks: None

Handles: 2 side handles welded onto patch plates

Weight: 8.6 Kg (body + gasket + lid + clamp)