

Product Specification

Specification Number 675 A12615

Revision 03

Part No. 675 A12615

Description Stainless Storage Drum 15L

Materials of Construction:

- Body: 316L stainless steel
- Lid: 316L stainless steel
- Clamp: 304 stainless steel
- Handles: 304 stainless steel
- Gasket: Silicone (FDA 177.2600 and USP Class VI compliant)

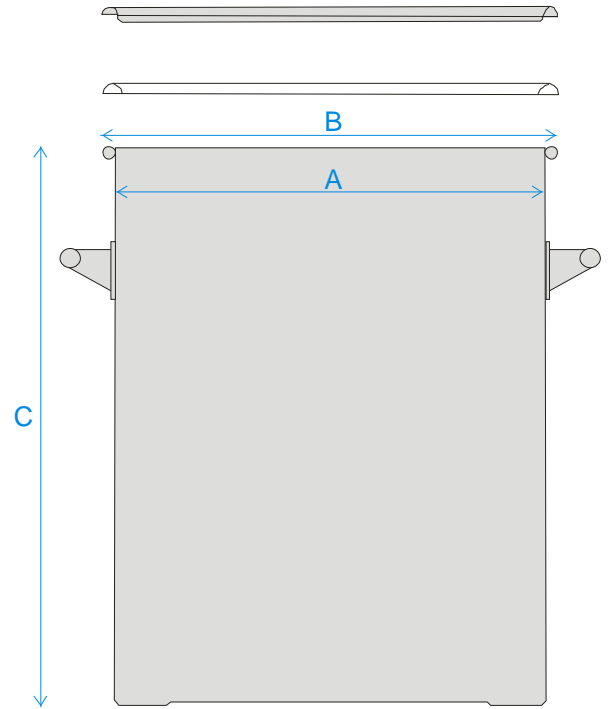

Nominal Volume: 15 Litres

Method of Construction: Welds ground and polished

Surface Finish: Better than 0.5 microns Ra

Dimensions
 A = 230 mm
 B = 250 mm
 C = 380 mm

Graduation Marks: None

Handles: 2 side handles welded onto patch plates

Weight: 5.45 Kg (body + gasket + lid + clamp)